

Article number: 439500045
 Description: Rota-fix shaft-hub connection F45x75
 Steel
 Note: Self centering. Very high torque

Measures

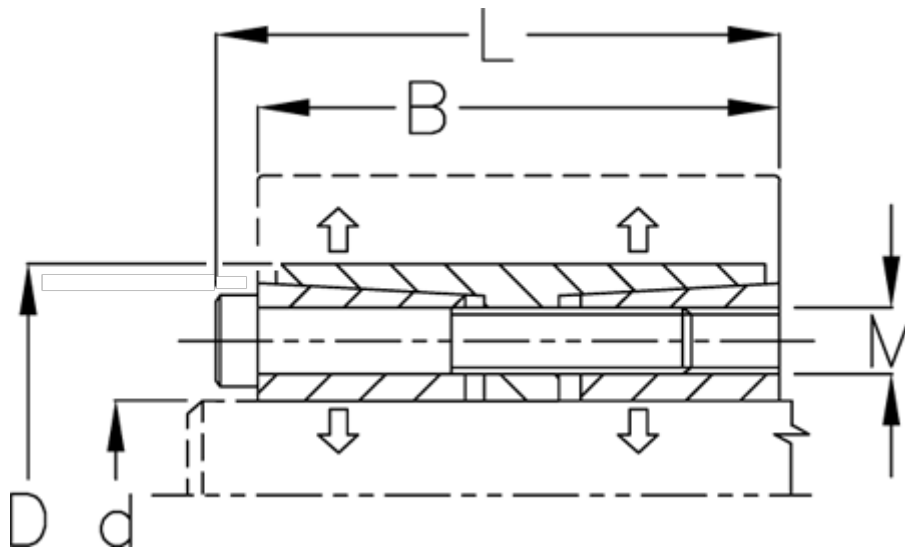

B mm	= 45
d H8 mm	= 45
D mm	= 75
Fit tolerance	= Aksel h8, Nav H8
F kN torque	= 140.0
L mm	= 51
M mm	= M8
P N/mm ² surface pressure on shaft/hub	= 130

Surface roughness	= R? ? 3.2 µm
T N m torque	= 3200
Ts N m bolt tightening torque	= 41.0